

BIG BERTHA™

DUMPBODY
VIBRATORS
MADE IN USA 

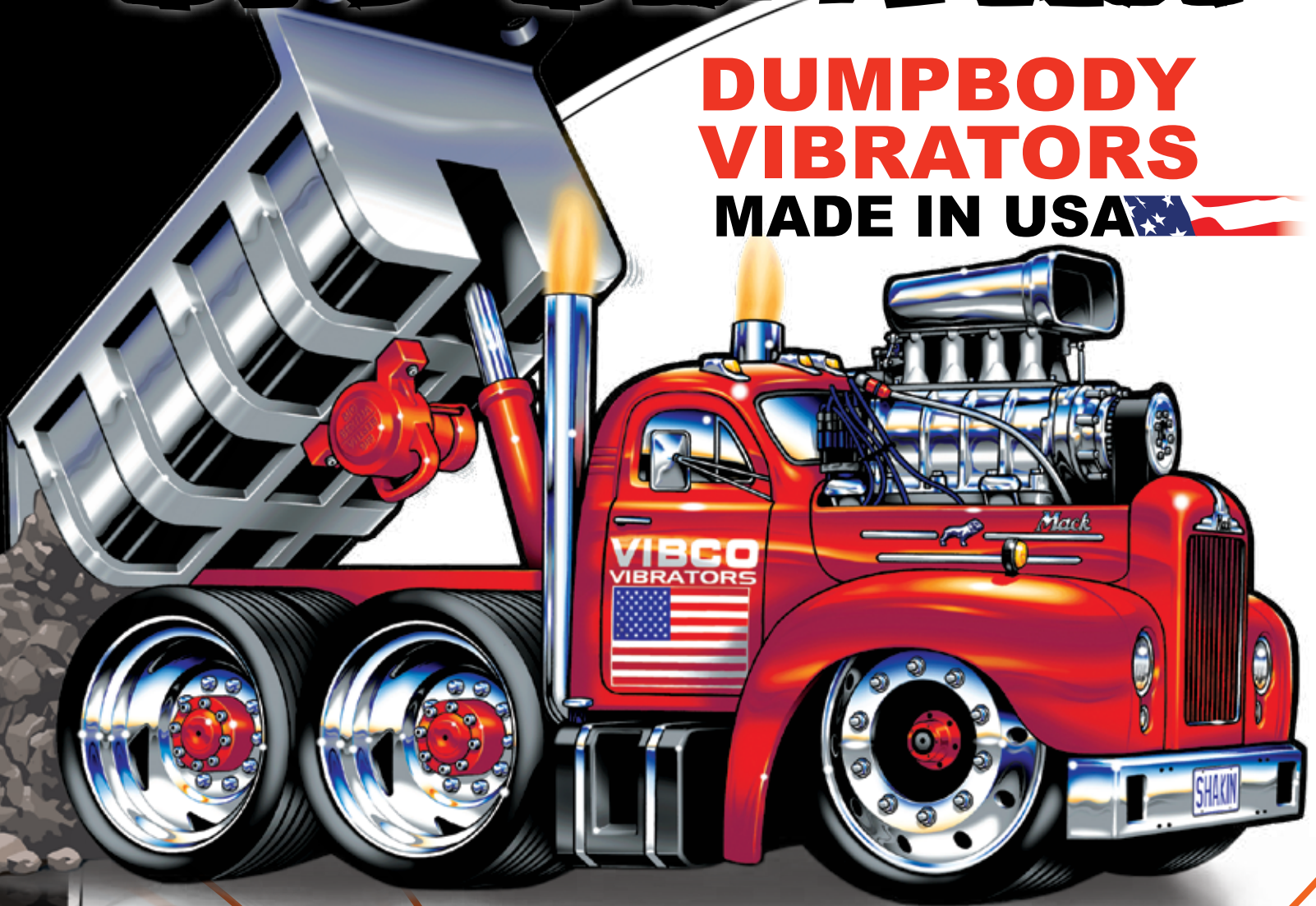

VIBCO®

VIBRATORS



DON'T LEAVE MATERIAL STUCK IN THE TRUCK!



- **We Believe** in **SUPPLYING EVERYTHING YOU NEED**
 - *FREE* 24 hour Technical Support at your fingertips
 - *FREE* Virtual Van Visit assist with your Bertha Mounting
 - *EASY* do it yourself installation - wiring provided
 - *NO WAITING* - Same Day Shipment
 - *PURCHASE LOCALLY* from our Extensive Dealer Network

- **We Believe** **YOU DESERVE POWER ON COMMAND**
 Big Bertha™ has the power to shake just about anything out of your dump body - concrete, fly ash, asphalt, mud, clay, loam, sand, salt, fertilizer, bottom ash, snow . . .

- **We Believe** in **KEEPING YOUR CREWS SAFE**
 - Reduce work related accidents & Insurance Premiums
 - No need to climb up steep ladders to clear out slick dump bodies
 - Less chance of rollover with dumping at lower angles

- **We Believe** in **HELPING YOU TO BE PROFITABLE**
 - Up to 3 extra payloads per day!
 - Dump faster and cleaner
 - Reduces idling time

BIG BERTHA™ SHAKES TOUGH MATERIALS OUT - LIKE HOT ASPHALT, CLAY, FERTILIZER, DREDGING MATERIAL, BOTTOM ASH, WET LOAM - FROM EVERY CORNER.

TO SELECT YOUR BERTHA CALL OR WRITE WITH THIS INFORMATION

Yardage _____ Available Power: 12V 24V Air _____ Hydraulic
 Lined? Heated?

Length (L) _____ Width (W) _____ Height (H) _____

Body of: Steel Aluminum Stainless • Truck Photo: high resolution phone is fine

CALL 800-633-0032 FOR A DEALER NEAR YOU (CANADA 800-465-9709)

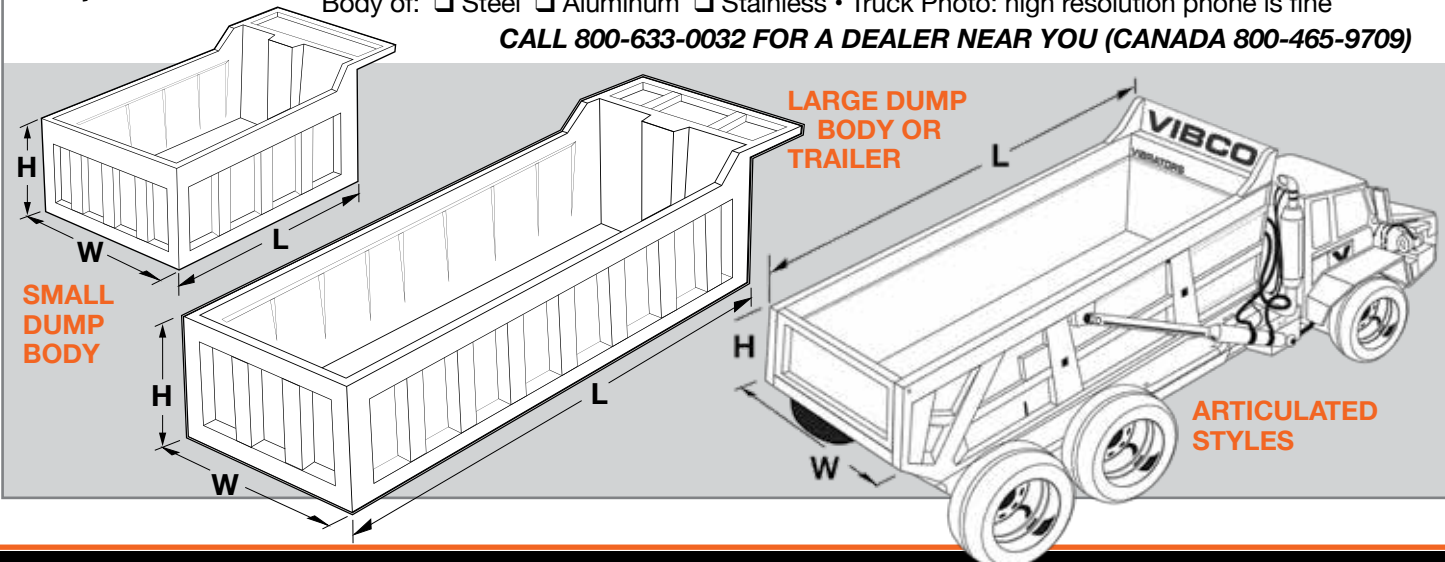

2 Dump faster so you can get back to load up

SHAKE IT OUT WITH **BIG BERTHA™**

ECO
FRIENDLY

- **We Believe** in OFFERING AFFORDABLE PRODUCTS
 - Costs less than one new truck tire.
 - A fraction of the cost of a new bed liner and it works better.
 - No more slamming brakes, banging tailgate or jerking hoists to get material out (or using a back hoe or excavator).
- **We Believe** in SIMPLICITY, LONGEVITY & QUALITY
 - Runs with a Simple push of a button from inside the cab, outside the cab, or by using remote control.
 - Will Outlast & Outrun the competition - bigger brushes, heavier, adjustable eccentrics provides more power & longer service life.
 - Fully enclosed housing keeps out road salt, dirt, water splash
- **We Believe** CROSS CONTAMINATION SHOULD BE PREVENTED
 - Materials in your loads will be fully dumped so no more clean stone mixed with prior load of fill
 - No more Inspection Fines
- **We Believe** ALL TRUCK TYPES DESERVE SOLUTIONS!
BERTHA works on all classes & styles of trucks
 - Class 6, 7, 8; on or off road; tri-axes; trailers; steel or aluminum truck bodies; belly or side dump; articulating, etc.



HC Trucking, Rhode Island

“Hauling hot asphalt in an aluminum body is tricky - and sticky - business. Without using our VIBCO vibrator, we’d be leaving a lot of product in the body at each dump site. With the cost of doing business these days, we are very happy to have a Big Bertha™ installed on our entire fleet.”



again . . . and again . . . & make more money. 3

VIBCO'S BERTHA

**NO LONG
LEAD TIMES!
SHIPS SAME
DAY!**



© VIBCO VIBRATORS 2008

BIG BERTHA™

DC ELECTRIC VIBRATOR



© VIBCO VIBRATORS 2019

XL BERTHA™

DC ELECTRIC VIBRATOR

The most powerful dump truck vibrator available - 5000 lbs of force!

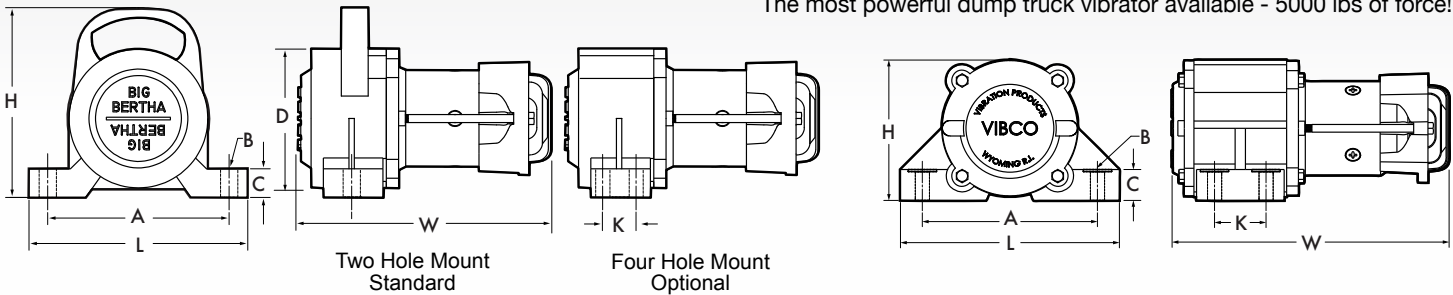

Two Hole Mount
Standard

Four Hole Mount
Optional

BIG BERTHA™ DIMENSIONAL DATA	L Length		W Width		H Height		A Bolt Spacing		B Bolt Size		C Foot Height		D Housing Height		K 4 Bolt Spacing	
	in	mm	in	mm	in	mm	in	mm	in	mm	in	mm	in	mm	in	mm
Model DC-3500-1500	10-1/8	257	12	305	9-1/8	232	8-1/2	216	3/4	19	1-3/8	35	6-1/4	159	-	-
Model DC-3500F-1500	10-1/8	257	12	305	7-1/8	181	8	203	5/8	16	1-3/8	35	6-1/2	165	2	51
TECH DATA	Weight		Centrifugal Force		Amps	Voltage	Max. Speed VPM		dB Decibel on A-scale at 3' (1 meter)	DUTY CYCLE						
	lbs.	kg.	lbs.	Newtons			Vibrations per Minute									
Model DC-3500-1500	34.7	15.7	3500	15,570	70/70	12 or 24 DC	4000		70	SPECIAL						
XL BERTHA™ DIMENSIONAL DATA	L Length		W Width		H Height		A Bolt Hole Spacing		B Bolt Size		C Foot Height		D Housing Height (w/o handle)		K Bolt Hole Spacing 2 (4 bolt only)	
	in	mm	in	mm	in	mm	in	mm	in	mm	in	mm	in	mm	in	mm
Model DC-5000	10-1/8	257	13-3/8	340	7-1/8	181	8	203	5/8	16	1-3/8	35	-	-	2	51
TECH DATA	Weight		Centrifugal Force		Amps	Voltage	Max. Speed VPM		dB Decibel on A-scale at 3' (1 meter)	DUTY CYCLE						
	lbs.	kg.	lbs.	Newtons			Vibrations per Minute									
Model DC-5000	40	18.1	5,000	22,240	70/70	12 or 24 DC	4000		72	SPECIAL						

Note: Materials, Data and Dimensions on this page subject to change without notice. Dim. ± 1/16. Engineered dimensional drawings available on request.

4 Like these graphics? Get limited edition VIBCO
1-800-633-0032 24/7 Tech Support & dealer near you **Order today online**

TRUCK VIBRATORS



© VIBCO VIBRATORS 2008

© VIBCO VIBRATORS 2008

HYDRA BERTHA™ HYDRAULIC VIBRATOR

AIR BERTHA™ PNEUMATIC VIBRATOR

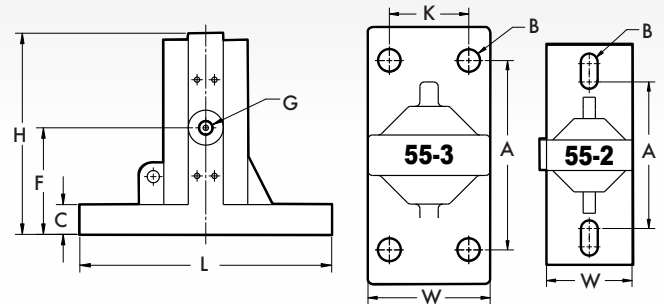
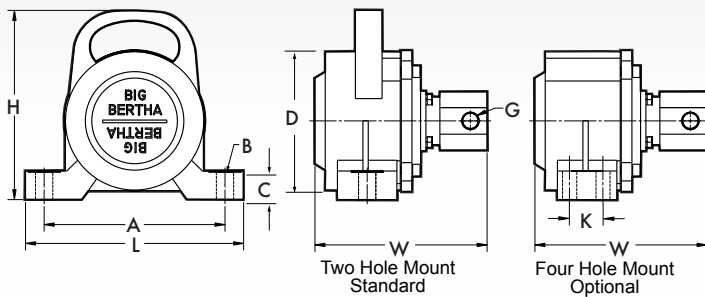

HYDRA BERTHA™ DIMENSIONAL DATA	L Length		W Width		H Height		A Bolt Spacing		B Bolt Size		C Foot Height		D Housing Height		K 4 Bolt Spacing		G Inlet/ Outlet Port
	in	mm	in	mm	in	mm	in	mm	in	mm	in	mm	in	mm	in	mm	
Models HLF-1750 & HLF-3500	10-1/4	260	8-9/16	217	9	229	8-1/2	216	3/4	19	1-3/8	35	6-1/2	165	-	-	3/4-16 SAE
Models HLF-1750 & HLF-3500	10-1/4	260	8-9/16	217	9	229	8-1/2	216	3/4	19	1-3/8	35	6-1/2	165	2	51	3/4-16 SAE
HLF-5000	10-1/4	260	8-9/16	217	7	178	8	203	3/4	19	1-3/8	35	6-1/2	165	2	51	3/4-16 SAE
TECH DATA	Weight		Pressure		Speed VPM		Gallon/min		Centrifugal Force		dB		DUTY				
	lbs.	kg.	PSI		VPM		GPM		lbs.	Newtons	Decibel on A-scale at 3' (1 meter)		CYCLE				
	Model HLF-1750	30	14.0	1,000		5,000		2.6		2,300		10,230		72	CONTINUOUS		
	Model HLF-3500	35	16.0	1,200		4,000		2.5		3,500		15,570		72	CONTINUOUS		
Model HLF-5000	41	18.6	1,500		4,000		2.5		4,500		20,020		72	CONTINUOUS			
AIR BERTHA™ DIMENSIONAL DATA	L Length		W Width		H Height		A Bolt Hole Spacing		B Bolt Size		C Foot Height		K 4 Bolt Spacing		F Air Inlet Height		I Air Inlet
	in	mm	in	mm	in	mm	in	mm	in	mm	in	mm	in	mm	in	mm	
Model 55-2	9	229	3-1/2	89	7-1/4	184	6 to 7-1/2	152 to 191	5/8	16	1-1/8	29	-	-	3-3/4	95	1/4-NPT
Model 55-3	10-1/2	267	5	127	9-7/16	240	7-3/4	197	7/8	22	1-1/8	29	3-1/2	83	4-3/4	121	3/8-NPT
TECH DATA	Weight		Force Impact		PSI		CFM		Speed VPM		dB		DUTY				
	lbs.	kg.	lbs.	Newtons	(max 110)				Vibrations per Minute	on A-scale at 3' (1 meter)		CYCLE					
	Model 55-2	20	10.4	800	3560	80	15	5000			99		CONTINUOUS				
Model 55-3	45	9.1	1500	6675	80	30	3800			104		CONTINUOUS					

*Decibel on A-scale at 3' (1 meter)

N+ = Centrifugal force in Newtons • Engineered dimensional drawings available on request.

T-shirts, temporary tattoos & hard hat stickers!
 at: stickers@vibco.com 800-465-9709 in Canada for dealer near you

CHOOSE YOUR VIBCO BERTHA VIBRATOR

CUBIC YARDAGE	BODY LENGTH	BIG BERTHA™	XL BERTHA™	AIR BERTHA™	HYDRA BERTHA™
2-8	10-12 ft	DC-3500-1500	—	55-2AB	HLF-1750
5-10	13-14 ft	DC-3500-2500	—	55-2AB	HLF-1750
8-16	15-16 ft	DC-3500-2700	—	(2) 55-3AB	HLF-3500
15-30	17-40 ft	DC-3500	DC-5000	(2) 55-3AB	HLF-5000

CONSULT FACTORY FOR ARTICULATING OFF ROAD TRUCK DUMP BODIES

OPTIONAL ACCESSORIES

OPTION	BIG BERTHA™	XL BERTHA™	AIR BERTHA™	HYDRA BERTHA™
Alternative 4 bolt foot pattern for easy cross-over of competitive models	✓			✓
Force adjusted eccentrics available to work best with your dumpbody dimensions & yardage capacity.*	✓	✓		✓
Variable cable/wire lengths to accommodate truck size or for interior/exterior switch applications.	✓	✓		✓
Complete mounting and wiring/plumbing kit optional.	✓	✓	✓	
Quick disconnect ideal for trailer applications	✓	✓	✓	✓
A variety of mounting plate & channel iron combinations: flat, extra long, extra wide or customized for your truck.	✓	✓	✓	✓
Aluminum mounting plates available for aluminum bodies (order unit DC-3500AL & plate part #1500PF38AL and XL Bertha mounting plate #1500P80AL).	✓	✓	✓	✓
No weld, bolt-on installation bracket for aluminum bodies (Part #93052).	✓		✓	✓
Optional Timer, TDC-2-24V, is available for 24V units like the DC-5000-24V and DC-3500-24V	✓	✓		
Customized timing sequences.	✓	✓	✓	
Custom fleet colors for larger orders.	✓	✓	✓	✓

*24/7 Tech Support 1-800-633-0032 (800-465-9709 Canada)

6 Use **BERTHA** to help dump dirt, salt, sand,

INSTALLING YOUR VIBCO VIBRATOR

AVERAGE INSTALL TIME IS LESS THAN 4 HOURS

BIG BERTHA™ & FULL INSTALLATION KIT

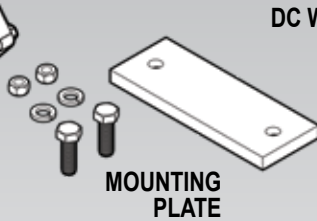
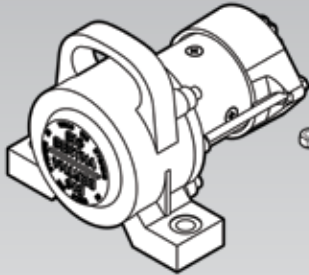

DC WIRING KIT

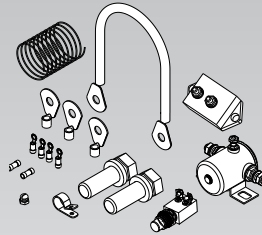

ACCESSORIES INCLUDED: 34' 4AWG cable (other lengths available) | Steel Mounting Plate | Bolts | Flat Washers | Lock Washers | Push Button switch | 12VDC Solenoid Valve | Circuit Breaker | Ring Terminals



Rob H., Syracuse, NY

"My shop guys could NOT believe how easy it was to install the Big Bertha™ vibrator on my truck! Having everything included with it along with the instructions was a huge plus. They were done in no time."

XL BERTHA™ & OPTIONAL ACCESSORIES

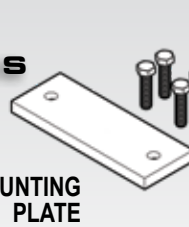
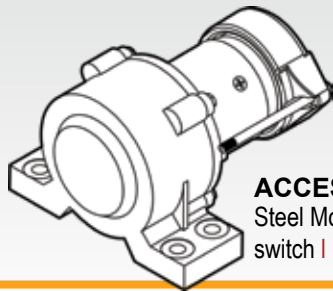

MOUNTING PLATE

DC WIRING KIT

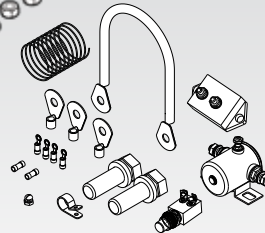

ACCESSORIES INCLUDED: 34' 4AWG cable (other lengths available) | Steel Mounting Plate | Bolts | Flat Washers | Lock Washers | Push Button switch | 12VDC Solenoid Valve | Circuit Breaker | Ring Terminals

AIR BERTHA™ & OPTIONAL ACCESSORIES

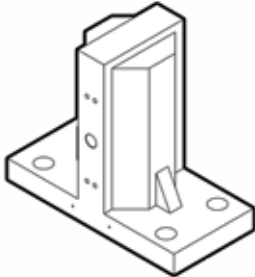

MOUNTING CHANNEL

ELECTRIC AIR CONTROL KIT

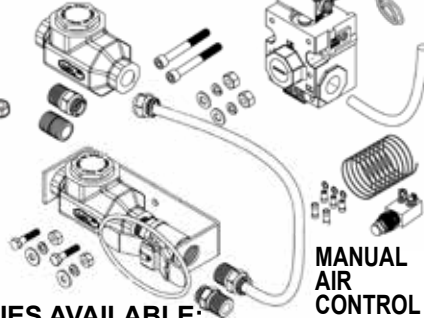

MANUAL AIR CONTROL KIT

OPTIONAL ACCESSORIES AVAILABLE:

40' DOT Grade Polyethylene Flexloc Hose & Fittings | Steel Mounting Plate | Lubricator | Bolts | Flat Washers | Lock Washers & your choice of **ELECTRIC KIT:** Push Button Switch | 12VDC Solenoid Valve | 20' 16 Gauge Wire | Ring Terminals or **MANUAL KIT:** Quick Acting Manual Valve | Mounting Bracket

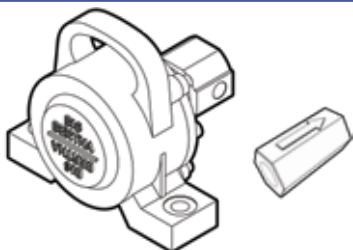

HYDRA BERTHA™ & OPTIONAL ACCESSORIES

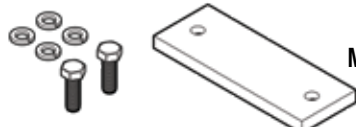

MOUNTING PLATE

OPTIONAL ACCESSORIES AVAILABLE: Steel Mounting Plate | Bolts | Flat Washers | Lock Washers | Hydraulic Accessories Available Separately from VIBCO

VIBCO's BIG BERTHA™

Mounting and Wiring Kit for the DC-3500 and DC-5000 is included with the vibrator. Optional mounting channel sold separately.

clay, fly ash, concrete, loam, gravel & more! 7

BIG BERTHA™ For Hard Hat Stickers

stickers@vibco.com

WITH A BERTHA BY VIBCO



REDUCE DOWNTIME
and potential clean out injuries too! Bertha moves even the toughest materials: clay, wet loam, concrete, hot asphalt - QUICKLY, SAFELY, COMPLETELY.

WITHOUT A BERTHA

When the box raises high to dump the load, an uneven base or soft soil can make a big difference and can lead to disaster! The illustration (right) shows how the center of gravity shifts creating a real tipping danger.

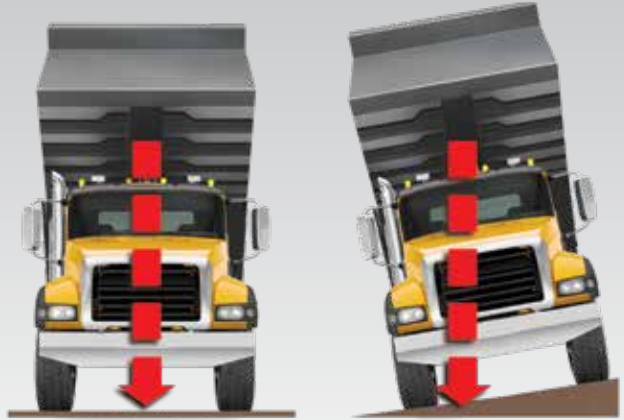

The higher the box raises and the heavier the load stuck at the top, the more dangerous the tipping situation becomes. When raising the box to higher levels to remove loads you risk coming in contact with power lines and potential deadly results.

A Big Bertha™ can greatly reduce the tip-over risk by getting the load out of the top of the box while the angle of the bed is lower, (creating a lower center of gravity).

Choose SAFETY & Efficiency!
Choose Big Bertha™!

Get FREE VIBCO Catalogs on all of our Concrete & Construction Products!



SandBuster DC Vibrators

- ▶ SandBuster salt & sand spreader hopper vibrators
- ▶ 10 models available to work with every spreader model



Plate Compactors & Rollers

- ▶ 12" to 24" plates & rollers
- ▶ Reversible & single directional plates
- ▶ Electric or gas powered

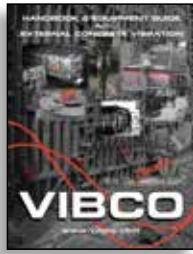

External Concrete Vibrators

- ▶ How-to Booklet
- ▶ 71 Application Photos
- ▶ Selection & Placement Guide



Internal Concrete Vibrators

- ▶ Electric 1 3/8" to 2 1/2" heads
- ▶ Pneumatic 1 3/8" to 3" heads
- ▶ Interchangeable heads & shafts



Sand & Gravel Vibrators

- ▶ How-To Booklet
- ▶ Selection & Sizing Guide
- ▶ Pneumatic, Electric & Hydraulic Vibrators

VIBCO®

VIBRATORS

http://www.VIBCO.com • vibrators@vibco.com

[in](#) [f](#) [o](#) [t](#) #VIBCOsolutions

MADE IN USA

75 Stilson Road, Wyoming, RI 02898
tel: 401.539.2392 • 800.633.0032

CANADA

2215 Dunwin Drive, Mississauga, Ont. L5L 1X1
tel: 905.828.4191 • 800.465.9709